

A-Style 3-Blade Propeller

For use on : **Honda**

HA3 i

Sheet number

Step 1. Listing of Parts needed for installation

Rev. 5/21/2004

(Please check to make sure you have all the parts indicated below before beginning.)

A. Your Piranha Propeller is assembled from the following parts:

CENTER HUB	(1) CH1A
FRONT CAP	None: integral w/hub
REAR CAP	(1) RCA
BLADES	(3) A-Style Blades

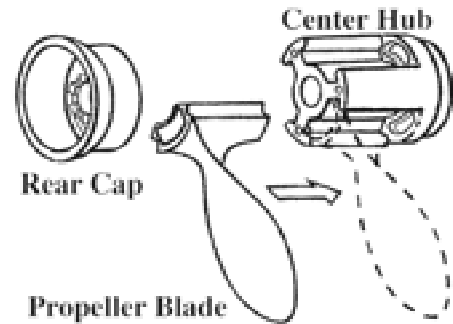

B. Additional parts supplied by Piranha:

- | | |
|---|--------------------|
| 1 | 3/4" SS flatwasher |
| 2 | Grease Packet |
| 3 | |
| 4 | |



Aqua Lube of Kentucky
(606) 873-0069

You must use some of your original propeller hardware as indicated on the right. Pictures of the necessary hardware, including that supplied with your new Piranha Propeller, are also shown below to help you confirm you have the correct parts. If you are missing any parts please call 800-235-7767 before proceeding.

C. Your Original Parts you must continue to use:

- | | |
|---|---------------------|
| 1 | Stock Thrust Washer |
| 2 | Stock Rear Spacer |
| 3 | Stock Prop Nut |
| 4 | Stock Cotter Pin |
| 5 | |

Hardware You Need in Order to Install Your Piranha Propeller:



HONDA Thrustwasher



3/4" Stainless Steel Flatwasher



Castellated Prop Nut



Cotter Pin

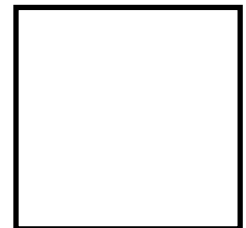

Step 2. Assembling a Piranha Propeller :

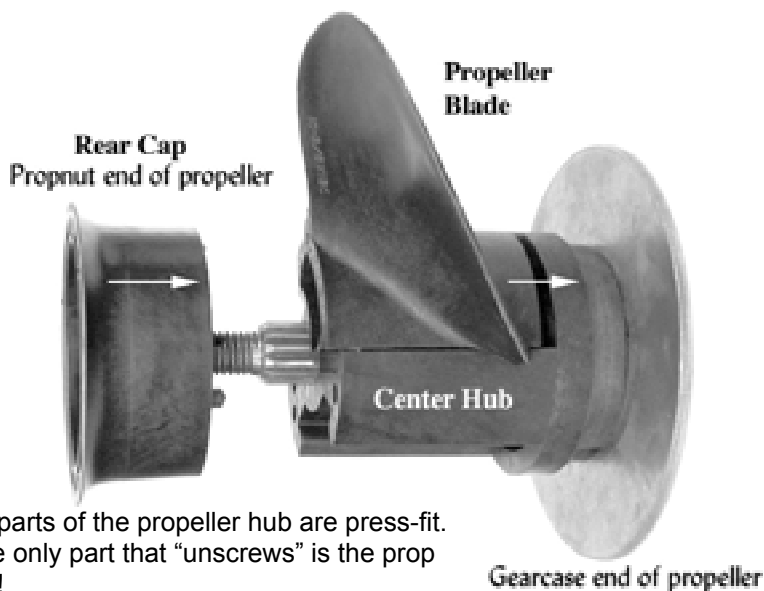

All parts of the propeller hub are press-fit. The only part that "unscrews" is the prop nut!

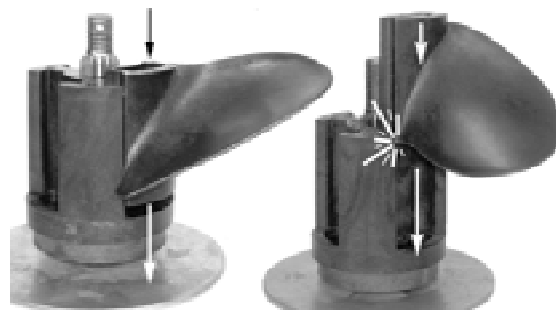

Correct

Incorrect

Note*: The blade sockets on a Piranha Propeller hub are tapered. This means the blades only fit in one way. When inserted from the correct side, the blade will effortlessly slide up to 96% of the way into the hub before meeting any resistance.

1. Insert the blades into the blade sockets until they bottom in the blade sockets. If they don't slide in easily, you may be trying to insert them upside down (see above). Tap them in all the way.
2. Press the rear cap onto the back of the prop hub to hold the blades in. Make sure any alignment pins fit correctly as shown below. The prop is now ready to go on the motor.

****Remember:** The prop nut is what holds the prop hub together. Press fit parts are only tight enough to hold the prop together until you get it installed on your motor with the nut and other necessary hardware on (see step 3).

Prop Assembly Final Check:

With the prop installed, double check to make sure that the caps on the propeller are correctly aligned with the hub as seen at right. If mis-aligned, the caps will block the exhaust ports as shown below. This will cause poor performance, over heating, and can damage the propeller.

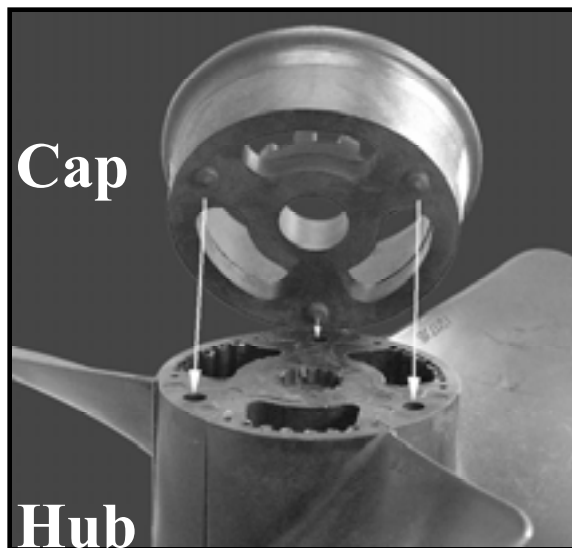

Correct alignment is achieved by ensuring that the index pins mate with the alignment holes on the hub and cap. Usually the pins are molded into the cap, but *sometimes* are on the hub instead. Note: the pins will not fully seat in the holes if the blades are not tapped into their slots completely. Check to make sure the blades touch the bottom of the socket when inserted.

Step 3. Installation Procedure:

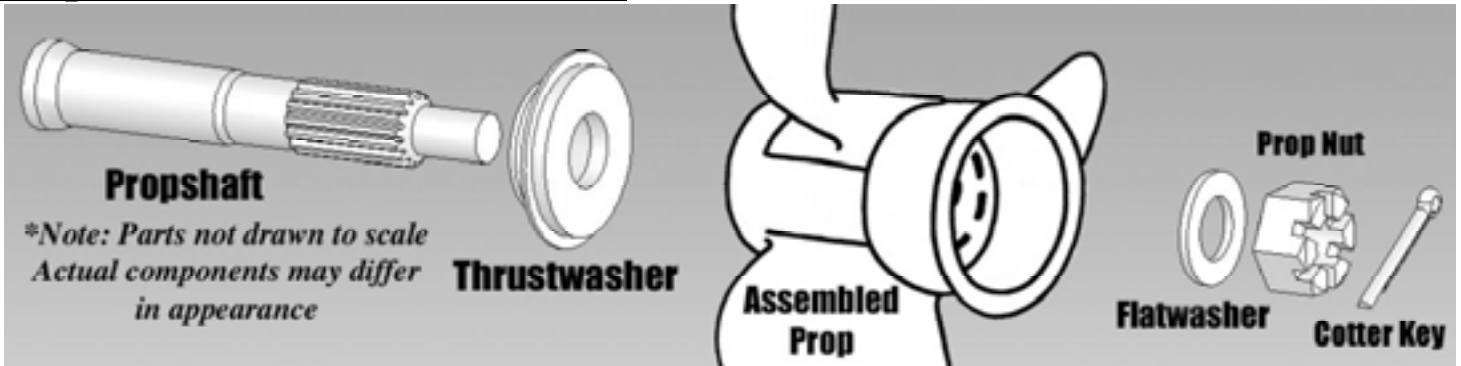

If you experience difficulty installing your propeller, double check these measurements. If you need help call us at 1-800-235-7767 and ask for technical support.

1. Remove your old propeller and hardware from your lower unit.
2. Thoroughly clean and then lube the driveshaft with the supplied marine grease.
3. Reinstall your original thrust washer on the shaft.
4. Install your new Piranha Prop.
5. Install the flatwasher supplied with your new prop.
6. Reinstall your original prop nut, and tighten it to at least 30 ft-lbs of torque.
7. Reinstall your cotter pin to retain the prop nut.

Important: Grease has been provided for your Prop installation. Props should be removed, inspected and the shaft re-greased every 6 months of salt water use, or 12 months of freshwater use. Cathodic protection anodes should be inspected annually by an authorized dealer.

WARNING : Make sure your newly installed prop *rotates easily* after you install it. If it does not, please call 800-235-7767 for technical support. Failure to do so may result in damage!

Special Considerations for your Application:

Dimensions of a properly fitting propeller hub are shown here for your use. If your prop does not seem to fit correctly, check your dimensions against these to help isolate where the trouble may lie. This is especially helpful if you need to call Tech support for help.

A = 5.54"
B = 1.83"
C = 1.34"
D = 4.36"
E = .68"

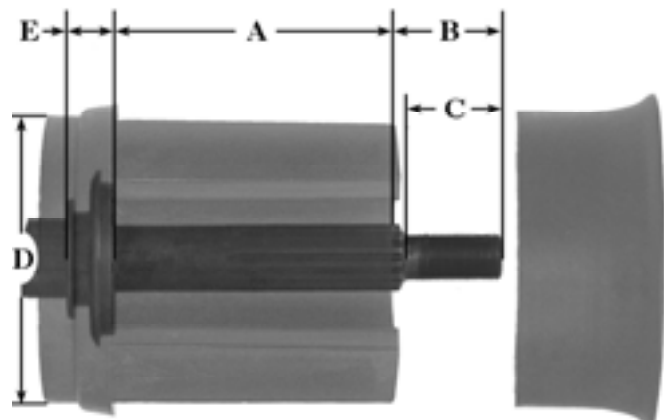

Step 4. Making sure you're propped correctly

Propeller Blade

Once you have your prop installed, it is important to make sure that the size of the blades is appropriate for your boat. You will need to know two things to determine this:

1.) Your Manufacturer's recommended Wide-Open Throttle RPM range.

Check- take your boat out for a top speed run. With the motor trimmed up, running wide open, your rpm needs to be within the correct range.

2.) How you intend to use your boat.

Check- try the prop! If it does what you want it to do, then you have the right prop!!

The Right Prop...Guaranteed: Blade Exchanges

If you find that the blades you have installed aren't quite right, a blade exchange may be able to get you running the way you want. If you are not sure what size to try, please call tech support for advise.

To arrange a blade exchange for a different size, just do the following:

1.) Contact the company you originally bought the prop from to arrange an exchange. If you prefer to conduct an exchange through the factory, you may do so, though you will incur a shipping charge.

2.) Clean the items to be exchanged of all grease, dirt and foreign matter (to avoid a cleaning charge). All exchange items must be in "like-new" resellable condition.

3.) Return the blades as previously arranged.



Piranha Propellers
3681 Sacramento Dr. Ste.D
San Luis Obispo, CA. 93401
Ph: (800) 235-7767
FAX: (805) 781-3852

E-MAIL: sales@piranhapropellers.com



Replacement parts:

For replacement part information, please contact your local dealer. Replacement Piranha parts can also be obtained by contacting our Customer Service Department.

To make it easier to get replacement parts, please write down the part number of your new propeller on the line below. Keeping this information with your records will make it easier to get the correct replacement parts in the future.

Hub Assy part # (e.g. MB4): _____

Blades used part # (e.g. 1318B-4): _____

Technical Support:

If you experience a problem at any time in the installation process, or you are unsure about a step, please call us and we can walk you through the problem. Application experts are available M-F, 8:00am to 5:00 pm PST simply by calling 1-800-235-7767.